

Collect





Il nuovo catalogo SOVIL COLLECT nasce dall'unione delle nostre tre brochures, Umbe Short e Led, insieme alla nuova linea Stem, presentato con l'aggiunta di alcune novità sia classiche che di design contemporaneo. "SOVIL COLLECT" è stato pensato per agevolare la lettura e la ricerca dei numerosi articoli presentati. Esso racchiude quindi quattro linee, volte ad accontentare ogni esigenza di un mercato sempre più qualificato riuscendo a soddisfare le più disparate richieste di professionisti, architetti, ingegneri e grandi installatori. Da anni SOVIL, leader nel settore dell'illuminazione per esterni, riesce a conquistare il mercato con professionalità, dinamicità e tempestività, riuscendo a dare un servizio sempre più completo, una scelta sempre più ricca, una qualità sempre più alta.

SOMMARIO

04 Stem



20 Umbe



44 Led



64 Short





Stem

Gli elementi della linea STEM, dal design pratico e moderno, sono l'ideale rappresentazione della luce educata, elegante e leggera, riescono a donare quel tocco di personalità che contraddistingue l'essenza della linea. Paletti e applique sono realizzati in alluminio con diffusori in materiale termoplastico o vetro a seconda del modello. Si integrano con facilità in ogni tipo di ambiente verde, ideali per arredare, camminamenti, giardini e verande.





560/16

Appliche con struttura in pressofusione di alluminio • Diffusore in termoplastico opalino • Adatta esclusivamente per lampade a risparmio energetico (H max 175 mm, Ø max 50 mm).

560/16 Grigio
EAN: 8020588666339

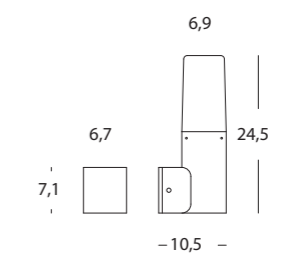

Palo con struttura in pressofusione di alluminio • Diffusore in termoplastico opalino • Adatto esclusivamente per lampade a risparmio energetico (H max 175 mm, Ø max 50 mm).

561/16 Grigio
EAN: 8020588666445

561/16

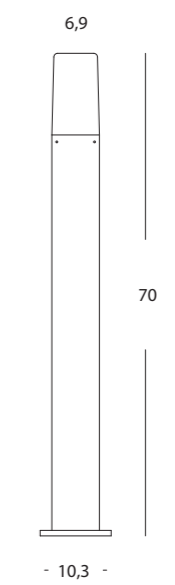

CE	CL1	230V	IP44	E27	max 25W	COLORE	● /16
----	-----	------	------	-----	---------	--------	-------

Applique con struttura in pressofusione di alluminio • Diffusore in termoplastico opalino
 • Adatta esclusivamente per lampade a risparmio energetico (H max 160 mm).



558/72 Alluminio
 EAN: 8020588666117

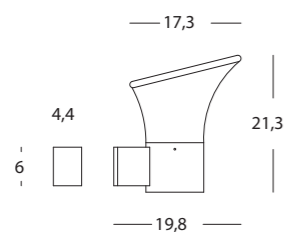

558/72

Palo con struttura in pressofusione di alluminio • Diffusore in termoplastico opalino
 • Adatto esclusivamente per lampade a risparmio energetico (H max 160 mm).



559/72 Alluminio
 EAN: 8020588666223

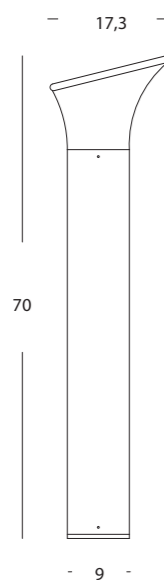

559/72



CE	CL1	230V	IP44	E27	max 25W	COLORE	● /72
----	-----	------	------	-----	---------	--------	-------



Pali con struttura in pressofusione di alluminio • Diffusore in policarbonato satinato
 • Adatto per lampade ad incandescenza e risparmio energetico (H max 150 mm, Ø max 60 mm).



205/06 Nero
 EAN: 8020588503061

209/06 Nero
 EAN: 8020588507069



207/06 Nero
 EAN: 8020588505065

210/06 Nero
 EAN: 8020588508066

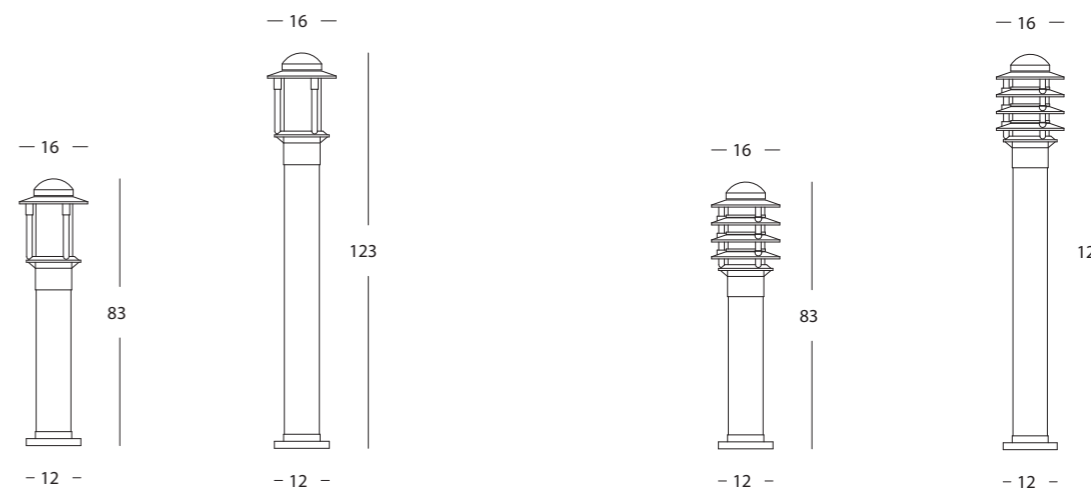

CE CL1 230V IP43 E27 max 60W

COLORE ● /06



Palo basso con struttura in pressofusione di alluminio • Diffusore in termoplastico opalino • Adatto esclusivamente per lampade a risparmio energetico (H max 180 mm, Ø max 60 mm) • Lampada 20 W inclusa luce bianca.

Palo alto con struttura in pressofusione di alluminio • Diffusore in termoplastico opalino • Adatto esclusivamente per lampade a risparmio energetico (H max 180 mm, Ø max 60 mm) • Lampada 20 W inclusa luce bianca.



824/06 Nero
EAN: 8020588942006



825/06 Nero
EAN: 8020588943003



COLORE ● /06





484/72



Appliche con struttura in pressofusione di alluminio • Diffusore in termoplastico opalino • Adatta esclusivamente per lampade a risparmio energetico (H max 125 mm)



484/72 Alluminio
EAN: 8020588983337

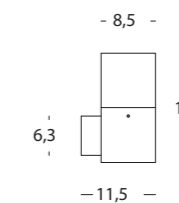

485/72



Palo con struttura in pressofusione di alluminio • Diffusore in termoplastico opalino • Adatto esclusivamente per lampade a risparmio energetico (H max 125 mm)



485/72 Alluminio
EAN: 8020588983320

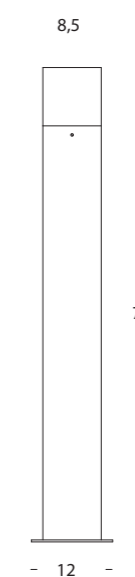

CE CL1 230V IP43 E27 max 25W

COLORE ● /72

Applique con struttura in pressofusione di alluminio • Diffusore in vetro trasparente
 • Adatta per lampade a risparmio energetico, alogene e Led (H max 76 mm).

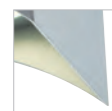

467/72 Alluminio
 EAN: 8020588215568

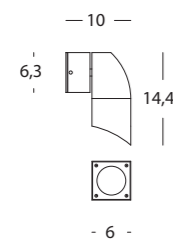

467/72

Applique due luci con struttura in pressofusione di alluminio • Diffusori in vetro trasparente
 • Adatta per lampade a risparmio energetico, alogene e Led (H max 76 mm).

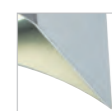

468/72 Alluminio
 EAN: 8020588215551

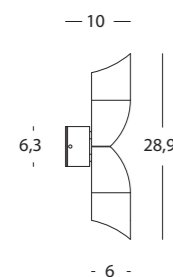

468/72



CE CL1 230V IP44 GU10 max 35W

COLORE ● /72



469/72

Palo una luce orientabile con struttura in pressofusione di alluminio • Diffusore in vetro trasparente • Adatto per lampade a risparmio energetico, alogene e Led (H max 76 mm).



469/72 Alluminio
EAN: 8020588215544

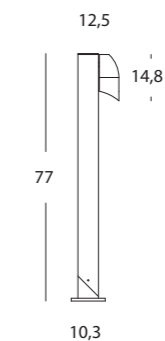

470/72

Palo due luci orientabili con struttura in pressofusione di alluminio • Diffusori in vetro trasparente • Adatto per lampade a risparmio energetico, alogene e Led (H max 76 mm).



470/72 Alluminio
EAN: 8020588963001

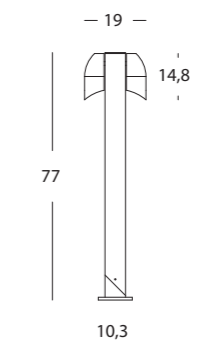

CE	CL1	230V	IP44	GU10	max 35W	COLORE	● /72
----	-----	------	------	------	---------	--------	-------

Umbe

Le applique e le plafoniere della linea UMBE sono realizzate in alluminio con diffusori in materiale termoplastico o vetro a seconda dei modelli. Gli elementi della linea sono adatti anche per l'inserimento in ambienti interni. Sono stati mantenuti lo stile minimale ed i volumi curvilinei che conferiscono un look moderno, leggero ed elegante. La linea UMBE, così come tutta la produzione SOVIL, nasce per le applicazioni outdoor. I punti luce, con grado di protezione IP54, sono ideali per arredare ambienti residenziali come terrazze, balconi e verande ma riscontrano un ottimo risultato anche quando vengono utilizzati in ambienti indoor come corridoi, living, bagni o cucine.





490/72

Appliche con struttura in pressofusione di alluminio • Diffusore in termoplastico satinato
 • Adatta per lampade (H max 140 mm) ad incandescenza e risparmio energetico.



490/16 Grigio
 EAN: 8020588193194



490/72 Alluminio
 EAN: 8020588193170

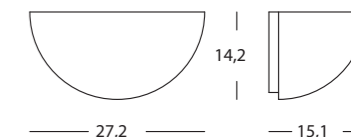

490/16



415/72

Applique con struttura in pressofusione di alluminio • Diffusori in vetro trasparente • Adatta esclusivamente per lampade a risparmio energetico (H max 108 mm, Ø max 45 mm).



415/02 Bianco
EAN: 8020588208027



415/16 Grigio
EAN: 8020588208010



415/72 Alluminio
EAN: 8020588208003

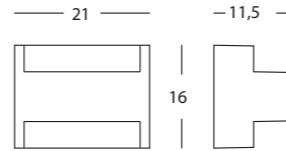

415/02



415/16



CE CL1 230V IP54 E27 25W

COLORE ○ /02 ● /16 ● /72



Applique con struttura in pressofusione di alluminio • Diffusori in vetro e termoplastico satinato • Adatta per lampade (H max 150 mm) ad incandescenza e risparmio energetico.



413/16 Grigio

EAN: 8020588208072



413/72 Alluminio

EAN: 8020588208065



413/16

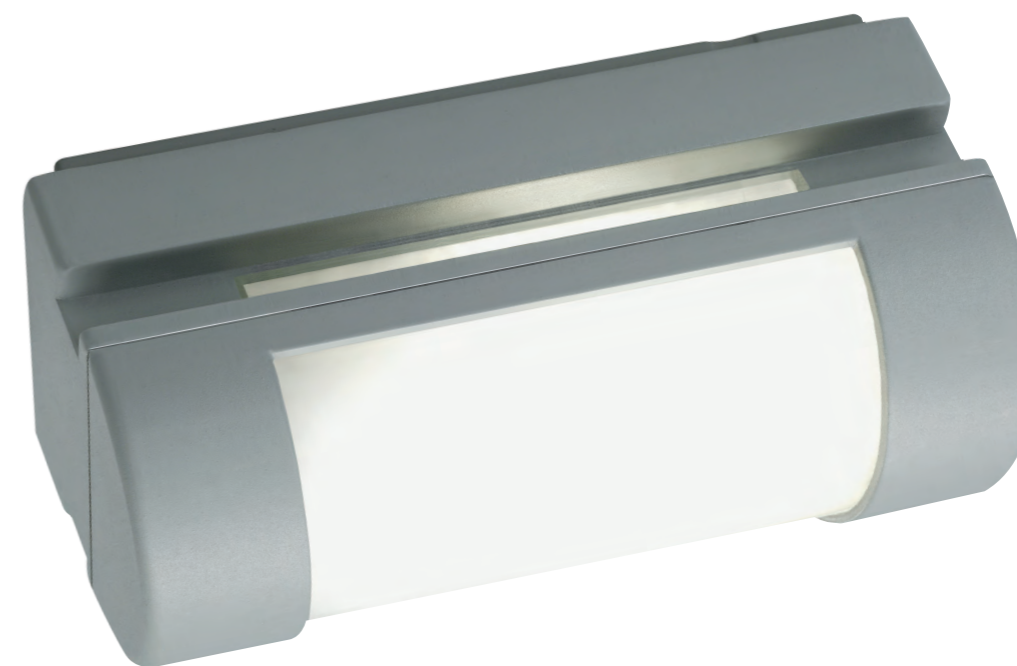

413/72



COLORE ● /16 ● /72

Applique con struttura in pressofusione di alluminio • Diffusore in termoplastico opalino • Adatta per lampade (H max 180 mm) ad incandescenza e risparmio energetico.



492/16 Grigio
EAN: 8020588866180

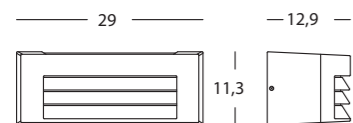

COLORE ● /16





473/16



473/36



473/72

Applique con struttura in pressofusione di alluminio • Diffusore in termoplastico opalino • Adatta per lampade (H max 145 mm) ad incandescenza e risparmio energetico.



473/16 Grigio
EAN: 8020588235061



473/36 Corten
EAN: 8020588214417



473/72 Alluminio
EAN: 8020588014451

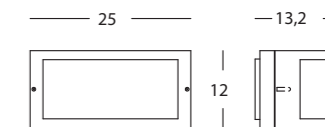

CE CL1 230V IP44 E27 max 60W

COLORE ● /16 ● /36 ● /72

Applique con struttura in pressofusione di alluminio • Diffusore in termoplastico opalino • Adatta per lampade (H max 145 mm) ad incandescenza e risparmio energetico.



474/16 Grigio
EAN: 8020588235016

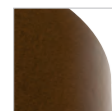

474/36 Corten
EAN: 8020588214400



474/72 Alluminio
EAN: 8020588014468

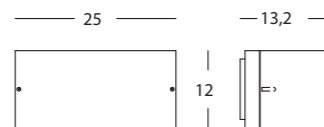

474/72



474/16



474/36

CE	CL1	230V	IP44	E27	max 60W	COLORE	● /16	● /36	● /72
----	-----	------	------	-----	---------	--------	-------	-------	-------





Applique con struttura in pressofusione di alluminio • Diffusore in termoplastico satinato • Adatta per lampade (H max 160 mm) ad incandescenza e risparmio energetico.



472/16 Grigio

EAN: 8020588208119



472/72 Alluminio

EAN: 8020588208102

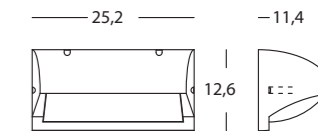

472/16



472/72



COLORE ● /16 ● /72



UP&DOWN



Applique con struttura in pressofusione di alluminio • Diffusore in termoplastico satinato • Adatta per lampade (H max 140 mm) ad incandescenza e risparmio energetico.



414/02 Bianco
EAN: 8020588208058



414/16 Grigio
EAN: 8020588208041



414/72 Alluminio
EAN: 8020588208034

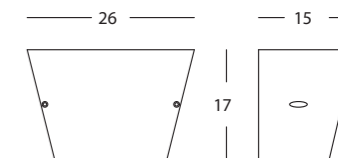

414/72



414/16



414/02

CE CL1 230V IP54 E27 max 60W

COLORE ○ /02 ● /16 ● /72

Applique o Plafoniera con struttura in pressofusione di alluminio • Diffusore in termoplastico satinato • Adatta per lampade (H max 160 mm) ad incandescenza e risparmio energetico.



471/16 Grigio

EAN: 8020588208133



471/72 Alluminio

EAN: 8020588208126

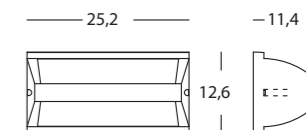

471/16



471/72



COLORE ● /16 ● /72

Applique o Plafoniera con struttura in pressofusione di alluminio • Diffusore in termoplastico satinato • Adatta per lampade (H max 160 mm, Ø max 60 mm) ad incandescenza e risparmio energetico.



412/02 Bianco
EAN: 8020588208096

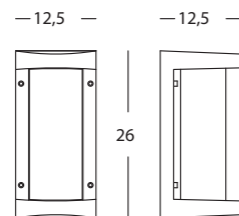

412/16 Grigio
EAN: 8020588208089

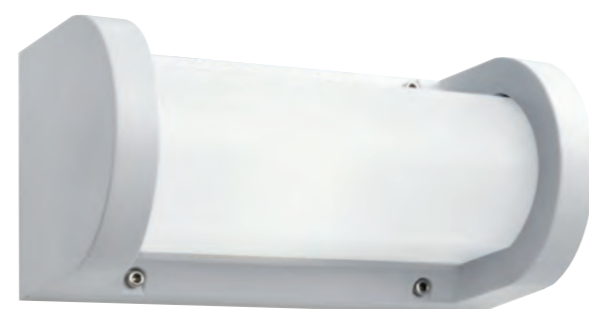

412/02



412/16



CE CL1 230V IP54 E27 max 60W

COLORE ○ /02 ● /16



Applique con struttura in pressofusione di alluminio • Diffusore in termoplastico satinato • Adatta per lampade (H max 180 mm, Ø max 50 mm) ad incandescenza e risparmio energetico.



493/06 Nero

EAN: 8020588014475



493/72 Alluminio

EAN: 8020588866173

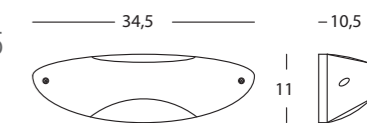

493/06

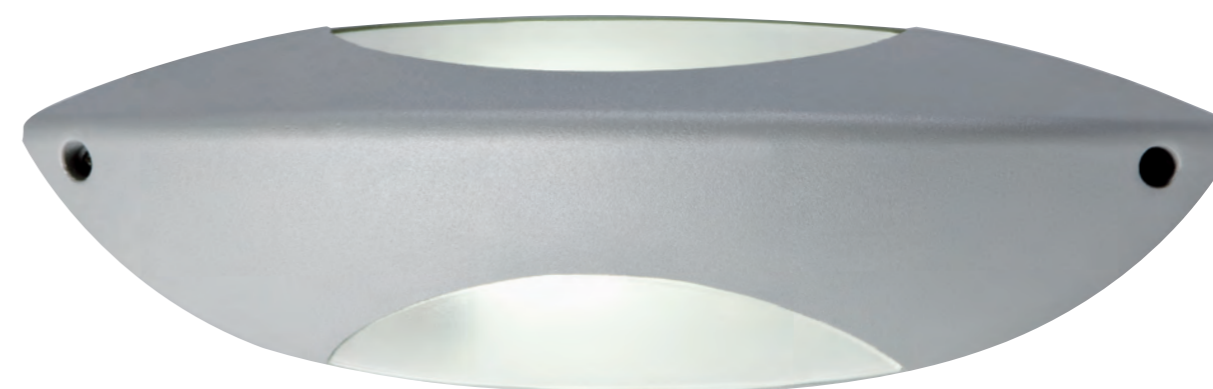

493/72



COLORE ● /06 ● /72



Led

Le soluzioni proposte in questa linea LED sono il frutto di investimenti su personale qualificato a livello nazionale ed internazionale. Ingegneri e designer, le cui competenze hanno garantito il raggiungimento dei migliori standard e di un livello estetico idoneo a soddisfare ogni tipo di progetto architettonico. Sono presenti uno spettro di prodotti ispirati all'innovazione, in linea con le più recenti tendenze in tema di qualità ed efficienza. L'elevato indice di protezione IP65, caratterizza tutti gli elementi della linea. Adatti per qualsiasi tipo di esigenza sia outdoor che indoor.



Plafoniera tonda piccola in termoplastico • Diffusore in termoplastico opalino
• Illuminazione a 41 LED SMD 8 W



99100/02 Bianco
EAN: 8020588200175



99100/16 Grigio
EAN: 8020588200168

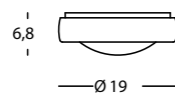

CE	CL II	230V	4000K	KIT	IP65	745 lumen	35mA	LED	DRIVER	COLORE	○/02	●/16
----	-------	------	-------	-----	------	-----------	------	-----	--------	--------	------	------

Plafoniera tonda media in termoplastico • Diffusore in termoplastico opalino
• Illuminazione a 82 LED SMD 13 W



99101/02 Bianco
EAN: 8020588200199



99101/16 Grigio
EAN: 8020588200182

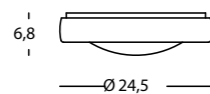

CE	CL II	230V	4000K	KIT	IP65	1400 lumen	59mA	LED	DRIVER	COLORE	○/02	●/16
----	-------	------	-------	-----	------	------------	------	-----	--------	--------	------	------

Plafoniera tonda grande in termoplastico • Diffusore in termoplastico opalino
• Illuminazione a 82 LED SMD 18 W



99102/02 Bianco
EAN: 8020588200274



99102/16 Grigio
EAN: 8020588200205

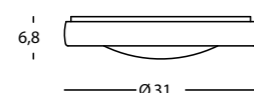

CE	CL II	230V	4000K	KIT	IP65	1800 lumen	80mA	LED	DRIVER	COLORE	○/02	●/16
----	-------	------	-------	-----	------	------------	------	-----	--------	--------	------	------





Plafoniera ovale grande in termoplastico • Diffusore in termoplastico opalino • Illuminazione a 82 LED SMD 18 W



99104/02 Bianco
EAN: 8020588200243

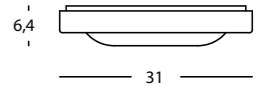

99104/16 Grigio
EAN: 8020588198526

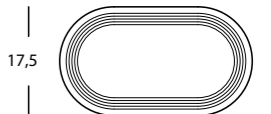

99104/02



Plafoniera ovale piccola in termoplastico • Diffusore in termoplastico opalino • Illuminazione a 41 LED SMD 8,5 W



99103/02 Bianco
EAN: 8020588200861

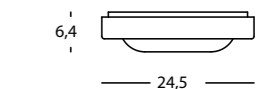

99103/16 Grigio
EAN: 8020588200298

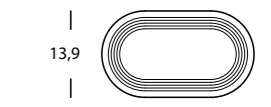

99103/16





99099/02



Plafoniera tonda in termoplastico • Diffusore in termoplastico satinato • Illuminazione a 42 LED SMD 8 W



99099/02 Bianco
EAN: 8020588965982

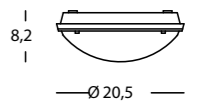

99098/02



Plafoniera ovale in termoplastico • Diffusore in termoplastico satinato • Illuminazione a 41 LED SMD 8 W



99098/02 Bianco
EAN: 8020588965975

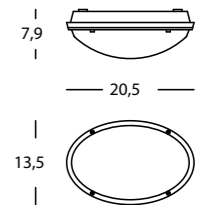

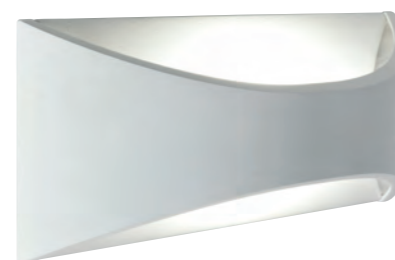

99107/02



Applique riflettente piccola in alluminio • Diffusore in termoplastico satinato • Illuminazione a 1 LED COB 6 W



99107/02 Bianco
EAN: 8020588200847



99107/27 Marrone
EAN: 8020588200250

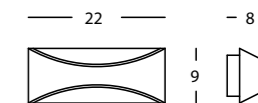

CE	CL1	230V	4000K	KIT	IP65	320 lumen	100mA	LED	DRIVER	COLORE	○/02	●/27
----	-----	------	-------	-----	------	-----------	-------	-----	--------	--------	------	------

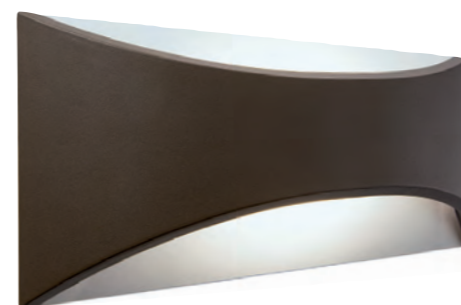

99108/27



Applique riflettente grande in alluminio • Diffusore in termoplastico satinato • Illuminazione a 1 LED COB 12 W



99108/02 Bianco
EAN: 8020588200748



99108/27 Marrone
EAN: 8020588200267

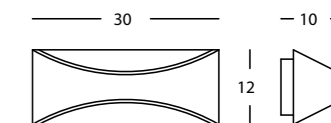

CE	CL1	230V	4000K	KIT	IP65	400 lumen	100mA	LED	DRIVER	COLORE	○/02	●/27
----	-----	------	-------	-----	------	-----------	-------	-----	--------	--------	------	------



Faretto conico orientabile in alluminio • Diffusore in vetro trasparente
 • Illuminazione a 1 LED COB 9 W



99105/16 Grigio
 EAN: 8020588198519

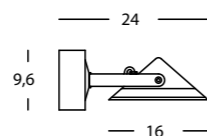

CE
CL1
230V
4000K
KIT
IP65
600 lumen
250mA
LED
DRIVER
COLORE ● /16



Faretto cilindrico orientabile e con messa a fuoco regolabile, in alluminio
 • Diffusore in vetro trasparente • Pressacavo PG9 • Illuminazione a 1 LED COB 9 W



99106/27 Marrone
 EAN: 8020588199028

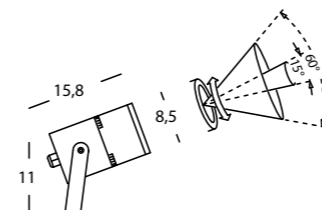

CE	CL1	230V	4000K	KIT	IP65	500 lumen	130mA	LED	DRIVER	COLORE ● /27
----	-----	------	-------	-----	------	-----------	-------	-----	--------	--------------

Faretto orientabile in alluminio • Diffusore in vetro trasparente
 • Cavo di alimentazione H05RN-F • Pressacavo PG7 •
 Illuminazione a 1 LED COB 6 W



99222/06 Nero
 EAN: 8020588965920

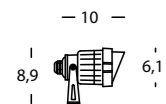

CE	CL1	230V	3000K	KIT	IP65	280 lumen	300mA	LED	DRIVER	COLORE ● /06
----	-----	------	-------	-----	------	-----------	-------	-----	--------	--------------

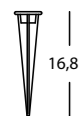

Accessorio
 Picchetto di supporto in alluminio
 27/06 Nero
 EAN: 8020588965937



Accessorio
 Ragno flessibile di supporto
 28/06 Nero
 EAN: 8020588965944





DOPPIA APPLICAZIONE

Questa linea di calpestabili non necessita di alcuno scasso o contro-scatola per l'installazione. Gli articoli vengono forniti con disco di fissaggio a terra (fig.1) e con picchetto (fig.2)

INSTALLAZIONE A PAVIMENTO (non necessita di scasso)



(fig.1)

INSTALLAZIONE A TERRA (picchetto incluso)



(fig.2)

Lampada segna passo 1 apertura in alluminio calpestabile (max 500 kg) • Diffusore in termoplastico trasparente • Picchetto di supporto incluso • Pressacavi PG9 • Illuminazione a 1 LED SMD 1 W



99109/16 Grigio
EAN: 8020588198489

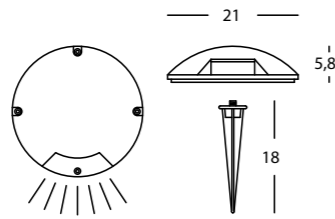

CE CL I 230V 4000K KIT IP65 100 lumen 40mA LED DRIVER COLORE ● /16

Lampada segna passo 2 aperture in alluminio calpestabile (max 500 kg) • Diffusore in termoplastico trasparente • Picchetto di supporto incluso • Pressacavi PG9 • Illuminazione a LED SMD 2*1 W (2 W)



99110/16 Grigio
EAN: 8020588200281

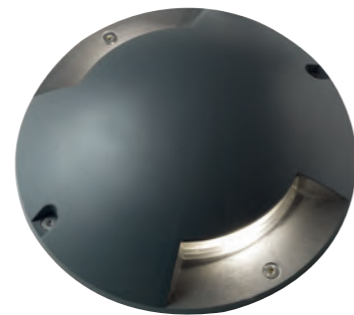
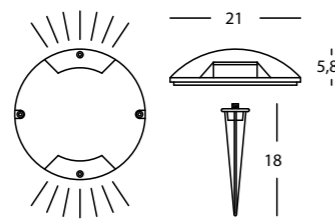

CE CL I 230V 4000K KIT IP65 200 lumen 80mA LED DRIVER COLORE ● /16

Lampada segna passo 4 aperture in alluminio calpestabile (max 500 kg) • Diffusore in termoplastico trasparente • Picchetto di supporto incluso • Pressacavi PG9 • Illuminazione a LED SMD 4*1 W (4 W)



99111/16 Grigio
EAN: 8020588200724

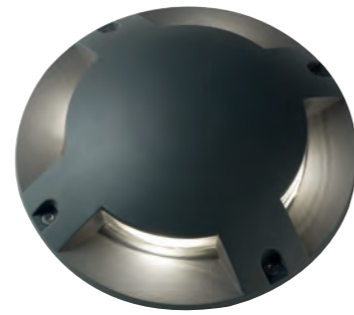
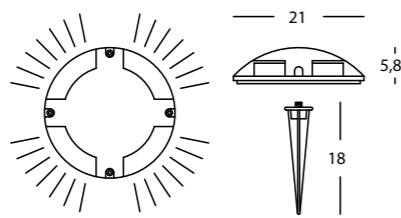

CE CL I 230V 4000K KIT IP65 400 lumen 100mA LED DRIVER COLORE ● /16





Short

Pregiata selezione di lanterne e mezza-lanterne in alluminio con trattamento a polveri epossidiche per garantirne la durevolezza. L'idea di un monografico di sole applique nasce dalla volontà di soddisfare senza vincoli la più ampia e diffusa esigenza del mercato. L'ampia scelta di colori, dal classico grigio antracite al moderno bianco-argento passando per il rame, assicura il perfetto adattamento ad ogni stile outdoor e rende la luce protagonista del giardino.



Sh



ort





Applique con struttura in pressofusione di alluminio • Diffusore in termoplastico trasparente • Adatta per lampade (H max 160 mm) ad incandescenza e risparmio energetico.



568/42



568/42 Nero Oro
EAN: 8020588759826



568/26 Bianco Oro
EAN: 8020588254796

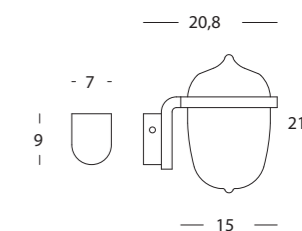

568/26

CE CL1 230V IP44 E27 max 40W

COLORE ● /42 ● /26

Appliche con struttura in pressofusione di alluminio • Diffusore in termoplastico trasparente • Adatta per lampade (H max 160 mm) ad incandescenza e risparmio energetico.



567/11 Ruggine
EAN: 8020588658976



567/37 Bianco Argento
EAN: 8020588365485

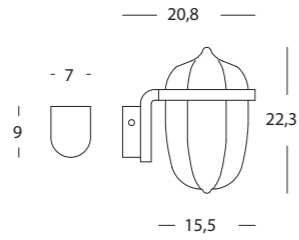

567/37



567/11

CE	CL1	230V	IP44	E27	max 40W	COLORE	● /11	● /37
----	-----	------	------	-----	---------	--------	-------	-------





Applique con struttura in pressofusione di alluminio • Copertura superiore color rame • Diffusore in vetro trasparente • Adatta per lampade (H max 140 mm) ad incandescenza e risparmio energetico.



330/38 Nero Rame
EAN: 8020588961625

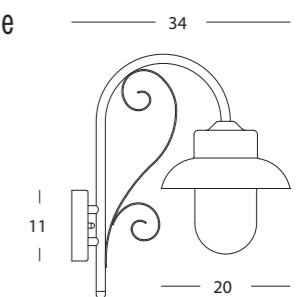

CE	CL1	230V	IP44	E27	max 60W	COLORE	 /38
----	-----	------	------	-----	---------	--------	---

Sospensione con struttura in acciaio e alluminio • Diffusore in vetro satinato
 • Cavo H05RN-F 3G0,75 • Adatta per lampade (H max 140 mm) ad incandescenza e risparmio energetico.



563/16 Grigio
 EAN: 8020588076145



563/26 Bianco Oro
 EAN: 8020588076152

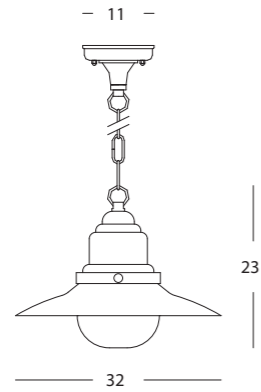

563/26



563/16

Applique con struttura in acciaio e alluminio • Diffusore in vetro satinato • Adatta per lampade (H max 140 mm) ad incandescenza e risparmio energetico.



562/16 Grigio
 EAN: 8020588076121



562/26 Bianco Oro
 EAN: 8020588076138

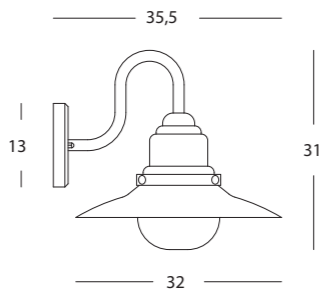

562/26

562/16



CE CL1 230V IP44 E27 max 60W

COLORE ● /16 ● /26



508/37

Applique con struttura in pressofusione di alluminio • Diffusore in termoplastico trasparente • Adatta per lampade (H max 115 mm) ad incandescenza e risparmio energetico.



508/06 Nero
EAN: 8020588200779



508/37 Bianco Argento
EAN: 8020588198359

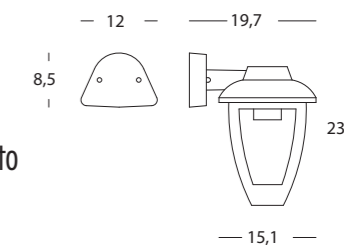

508/06

CE	Cl1	230V	IP43	E27	max 40W	COLORE	● /06	● /37
----	-----	------	------	-----	---------	--------	-------	-------

Applique con struttura in pressofusione di alluminio • Diffusore in termoplastico trasparente • Adatta per lampade (H max 110 mm) ad incandescenza e risparmio energetico.



513/06 Nero
EAN: 8020588198588

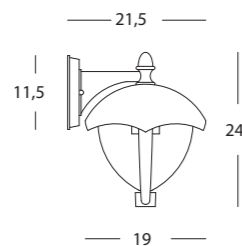

CE
CL1
230V
IP43
E27
max 40W
COLORE ● /06



Applique con struttura in pressofusione di alluminio • Diffusore in vetro trasparente pulegoso • Adatta per lampade (H max 155 mm) ad incandescenza e risparmio energetico.



775/11 Ruggine
EAN: 8020588231025

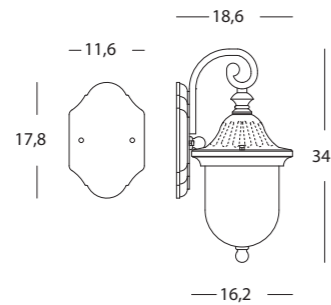

CE CL1 230V IP43 E27 max 60W

COLORE ● /11



Applique con struttura in pressofusione di alluminio • Diffusori in vetro trasparente molato • Adatta per lampade (H max 155 mm) ad incandescenza e risparmio energetico.



776/11 Ruggine
EAN: 8020588231087

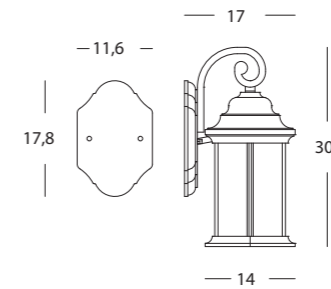

CE CL1 230V IP33 E27 max 60W

COLORE ● /11



Applique con struttura in pressofusione di alluminio • Diffusori in vetro trasparente martellato • Adatta per lampade (H max 155 mm) ad incandescenza e risparmio energetico.



774/12 Nero Argento
EAN: 8020588230080

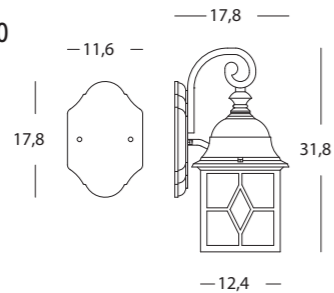

767/06

Applique con struttura in pressofusione di alluminio • Diffusori in vetro trasparente • Adatta per lampade (H max 170 mm) ad incandescenza e risparmio energetico.



767/06 Nero
EAN: 8020588210068

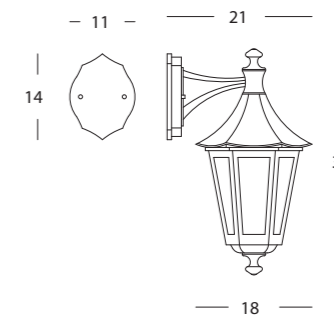

Applique con struttura in pressofusione di alluminio • Diffusori in vetro trasparente • Adatta per lampade (H max 170 mm) ad incandescenza e risparmio energetico.



766/06 Nero
EAN: 8020588210020

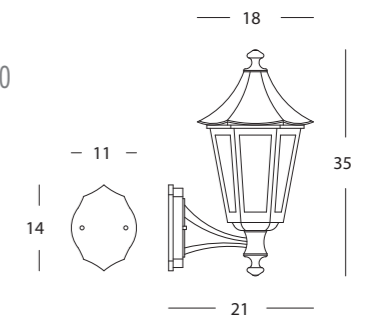

766/06



Applique con struttura in pressofusione di alluminio • Diffusore in termoplastico trasparente • Adatta per lampade (H max 130 mm) ad incandescenza e risparmio energetico.



888/16 Grigio
EAN: 8020588238017

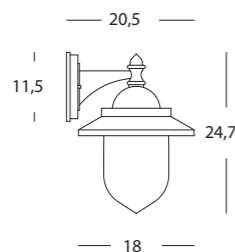

Applique con struttura in pressofusione di alluminio • Diffusore in vetro stampato trasparente • Adatta per lampade (H max 145 mm) ad incandescenza e risparmio energetico.



327/06 Nero
EAN: 8020588302060

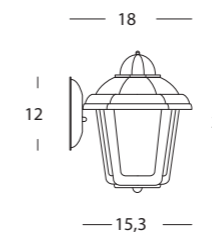



890/14

Applique con struttura in pressofusione di alluminio • Copertura superiore color rame • Diffusore in termoplastico trasparente • Adatta per lampade (H max 130 mm) ad incandescenza e risparmio energetico.



890/14 Grigio Rame
EAN: 8020588237034

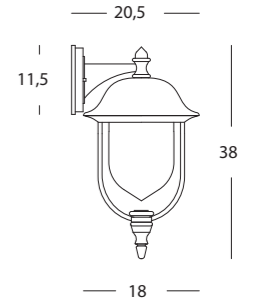

891/14

Applique con struttura in pressofusione di alluminio • Copertura superiore color rame • Diffusore in termoplastico trasparente • Adatta per lampade (H max 130 mm) ad incandescenza e risparmio energetico.



891/14 Grigio Rame
EAN: 8020588237010

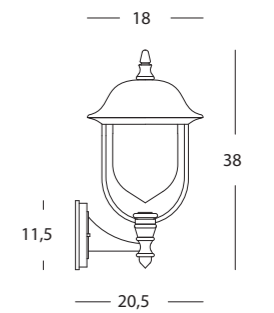

CE CL1 230V IP43 E27 60W

COLORE  /14



Appliche con struttura in pressofusione di alluminio • Diffusori in vetro trasparente martellato • Adatta per lampade (H max 140 mm) ad incandescenza e risparmio energetico.



507/16 Grigio
EAN: 8020588200625

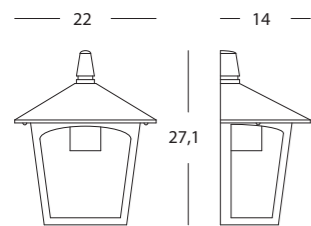

CE CL1 230V IP43 E27 max 60W

COLORE ● /16



Appliche con struttura in pressofusione di alluminio • Diffusore in termoplastico trasparente • Adatta per lampade (H max 125 mm) ad incandescenza e risparmio energetico.



512/16 Grigio
EAN: 8020588198670

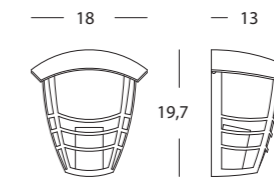

CE CL1 230V IP43 E27 max 40W

COLORE ● /16



326/06

Applique con struttura in pressofusione di alluminio • Diffusori in vetro trasparente • Adatta per lampade (H max 200 mm) ad incandescenza e risparmio energetico.



326/06 Nero
EAN: 8020588518065

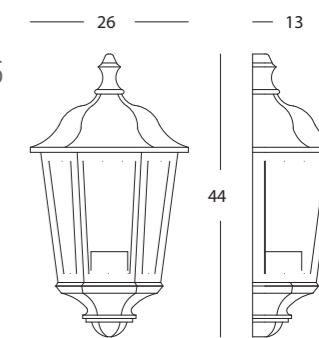

328/06

Applique con struttura in pressofusione di alluminio • Diffusori in vetro trasparente • Adatta per lampade (H max 160 mm) ad incandescenza e risparmio energetico.



328/06 Nero
EAN: 8020588948626

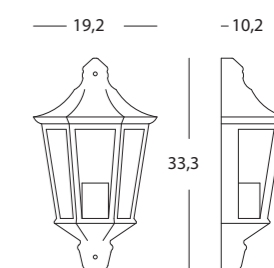

CE	CL1	230V	IP43	E27	max 60W	COLORE	● /06
----	-----	------	------	-----	---------	--------	-------



976/16

Applique con struttura in pressofusione di alluminio • Diffusori in vetro trasparente molato • Adatta per lampade (H max 170 mm) ad incandescenza e risparmio energetico.



976/16 Grigio
EAN: 8020588676000

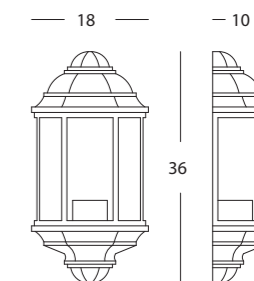

927/16

Applique con struttura in pressofusione di alluminio • Diffusori in vetro trasparente molato • Adatta per lampade (H max 170 mm) ad incandescenza e risparmio energetico.



927/16 Grigio
EAN: 8020588520006

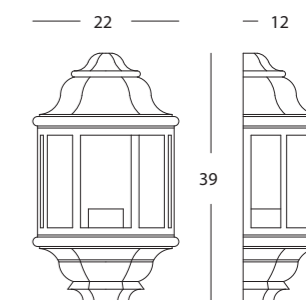

COLORE ● /16

Plafoniera ovale con struttura in termoplastico • Diffusore in vetro stampato
 • Adatta per lampade (H max 114 mm) ad incandescenza e risparmio energetico.



45/06 Nero
 EAN: 8020588568923



45/02 Bianco
 EAN: 8020588568916

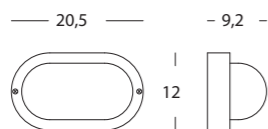

45/06

Plafoniera ovale con gabbia e struttura in termoplastico • Diffusore in vetro stampato
 • Adatta per lampade (H max 114 mm) ad incandescenza e risparmio energetico.



46/06 Nero
 EAN: 8020588658730



46/02 Bianco
 EAN: 8020588658723

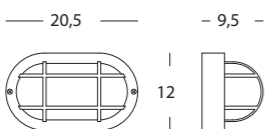

46/02





47/06

Plafoniera tonda con struttura in termoplastico • Diffusore in vetro stampato
 • Adatta per lampade (H max 107 mm) ad incandescenza e risparmio energetico.



47/06 Nero
 EAN: 8020588873669



47/02 Bianco
 EAN: 8020588873652

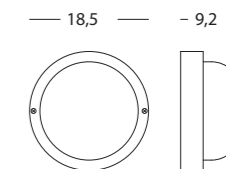

48/02

Plafoniera tonda con gabbia e struttura in termoplastico • Diffusore in vetro stampato
 • Adatta per lampade (H max 107 mm) ad incandescenza e risparmio energetico.

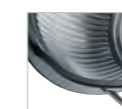

48/06 Nero
 EAN: 8020588367229



48/02 Bianco
 EAN: 8020588367212

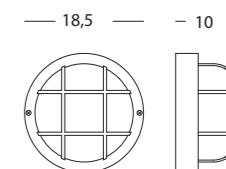

I disegni, le quote, i colori dei prodotti raffigurati nel presente catalogo sono a titolo indicativo.
La Sovil si riserva la facoltà di modificare senza preavviso le caratteristiche tecniche degli
elementi illustrati. Per ogni controversia si stabilisce la competenza del Foro di Viterbo.
Il presente catalogo sostituisce ed annulla l'edizione precedente.



Sovil srl
Via Crescenzo, 82 - 00193 Roma

sede Operativa ed Amministrativa :
Strada Statale n° 204 Ortana
01038 Soriano nel Cimino (Viterbo)
Tel. (+39) 0761 759303 – Fax (+39) 0761 759355
e-mail: info@sovil.com www.sovil.com

Fotografia e realizzazione grafica: Fotostudio Mauro Mattioli, Viterbo - Stampa: Tipografia Litograf Todì

Finito di stampare: MAGGIO 2016

